

## SS34F-HF Thru. SS320F-HF

Reverse Voltage: 40 to 200 Volts

Forward Current: 3.0 Amp

RoHS Device

Halogen Free

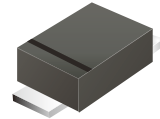

### Features

- Metal silicon junction, majority carrier conduction.
- For surface mounted applications.
- Low power loss, high efficiency.
- High forward surge current capability.
- For use in low voltage, high frequency inverters, free wheeling, and polarity protection applications.

### Mechanical data

- Case: SMAF
- Terminals: Solderable per MIL-STD-750, method 2026.

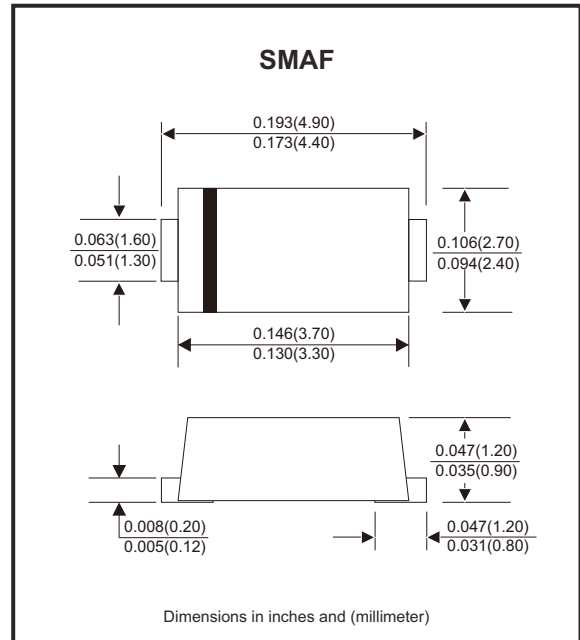

### Circuit Diagram



### Maximum Ratings and Electrical Characteristics

Ratings at 25°C ambient temperature unless otherwise specified.  
Single phase, half wave, 60Hz resistive or inductive load, for capacitive load, derate by 20%

Parameter	Symbols	SS34F-HF	SS36F-HF	SS310F-HF	SS315F-HF	SS320F-HF	Units
Maximum repetitive peak reverse voltage	V <sub>RRM</sub>	40	60	100	150	200	V
Maximum RMS voltage	V <sub>RMS</sub>	28	42	70	105	140	V
Maximum DC blocking voltage	V <sub>DC</sub>	40	60	100	150	200	V
Maximum average forward rectified current	I <sub>F(AV)</sub>	3					A
Peak forward surge current, 8.3ms single half sine-wave superimposed on rated load (JEDEC method)	I <sub>FSM</sub>	80					A
Max instantaneous forward voltage at 3A	V <sub>F</sub>	0.55	0.70	0.85	0.95		V
Maximum DC reverse current T <sub>J</sub> = 25°C at rated DC reverse voltage T <sub>J</sub> = 100°C	I <sub>R</sub>	0.5 5		0.3 3			mA
Typical junction capacitance (Note 1)	C <sub>J</sub>	250		180			pF
Typical thermal resistance (Note 2)	R <sub>θJA</sub> R <sub>θJC</sub>	70 18					°C/W
Operating junction temperature range	T <sub>J</sub>	-55 ~ +150					°C
Storage temperature range	T <sub>stg</sub>	-55 ~ +150					°C

Notes: 1. Measured at 1 MHz and applied reverse voltage of 4 V D.C  
2. P.C.B. mounted with 2.0" X 2.0" (5 X 5 cm) copper pad areas.

Company reserves the right to improve product design , functions and reliability without notice.

REV:A

## Rating and Characteristic Curves (SS34F-HF Thru. SS320F-HF)

Fig.1 - Forward Current Derating Curve

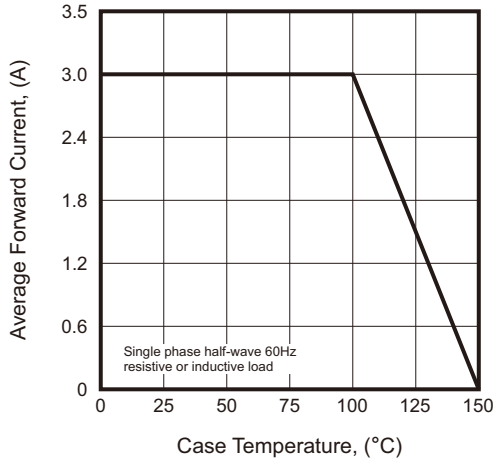

Fig.2 - Typical Reverse Characteristics

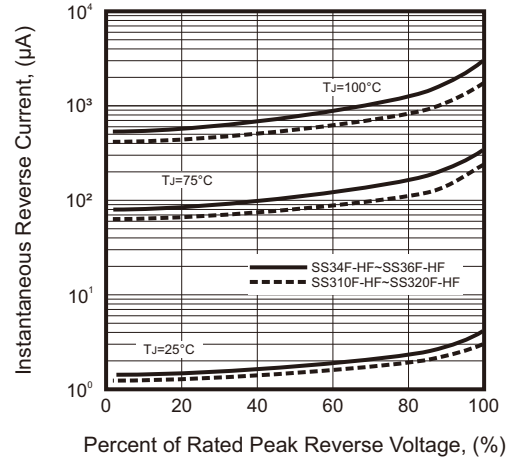

Fig.3 - Typical Forward Characteristic

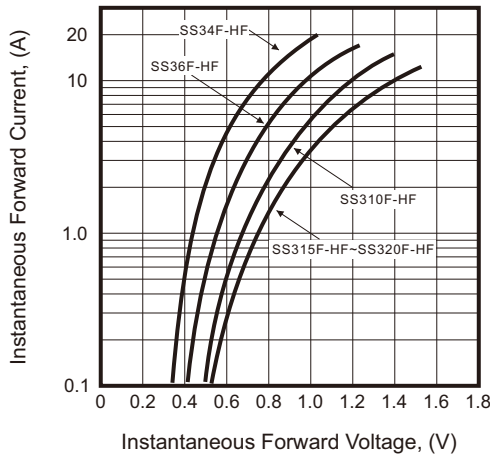

Fig.4 - Typical Junction Capacitance

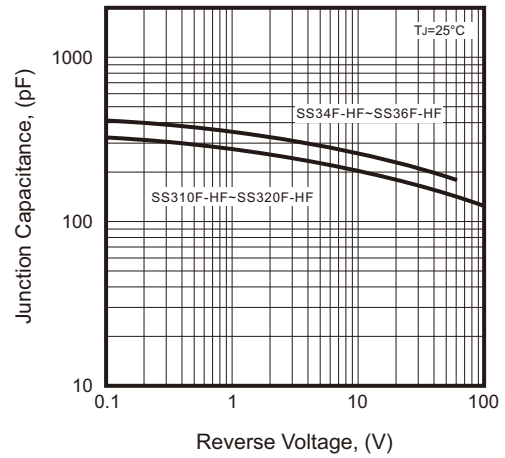

Fig.5 - Maximum Non-Repetitive Peak Forward Surge Current

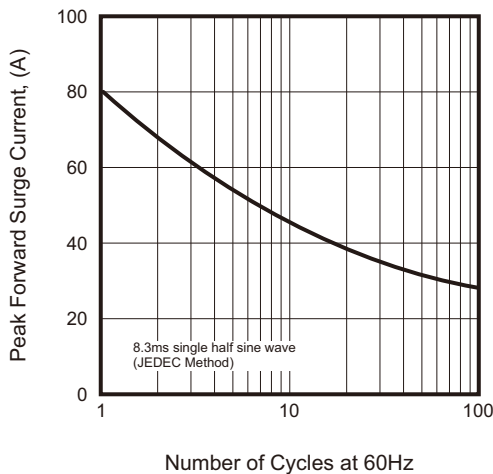
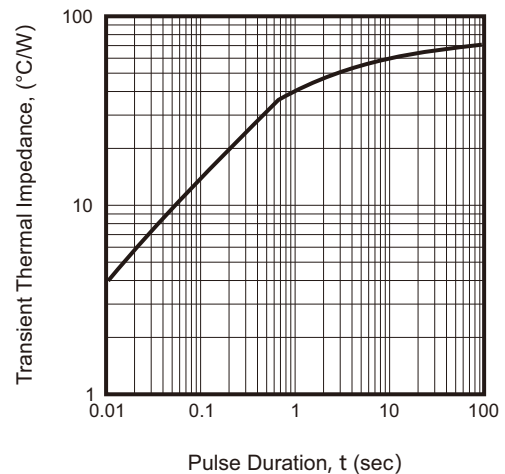
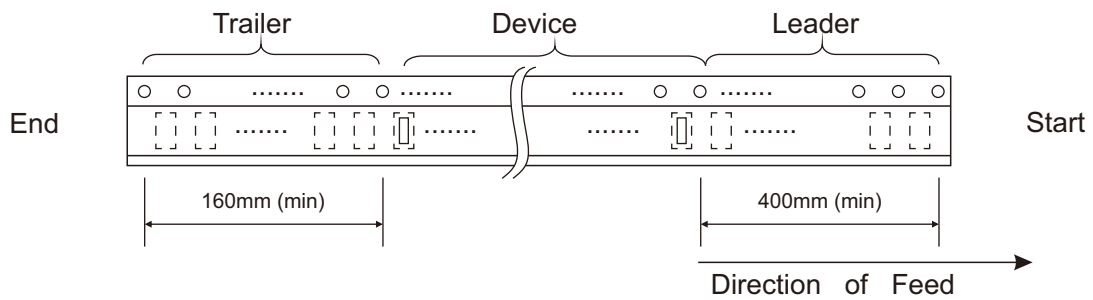
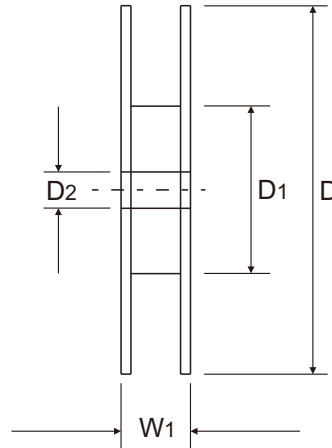
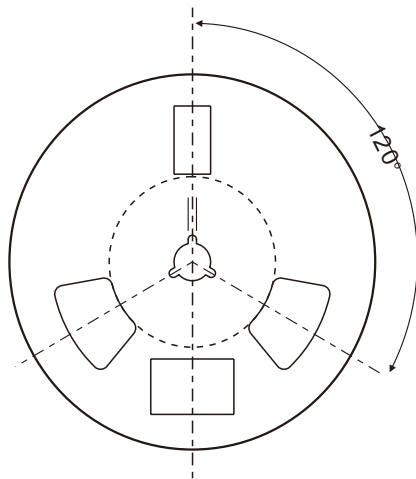
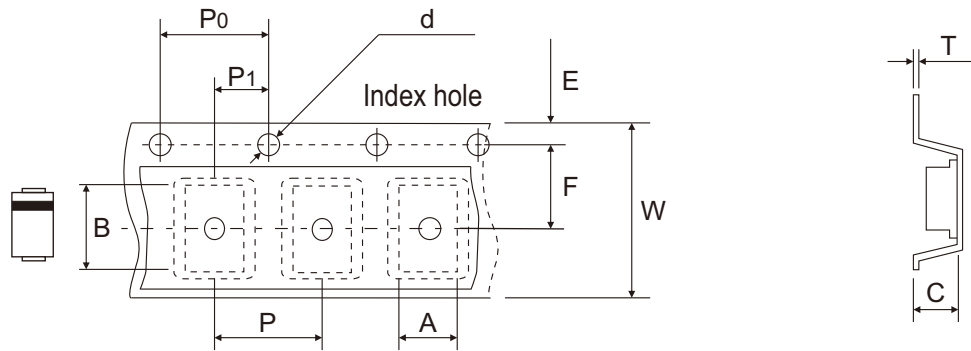

Fig.6 - Typical Transient Thermal Impedance



## Reel Taping Specification



SMAF	SYMBOL	A	B	C	d	D	D1	D2
	(mm)	2.93 ± 0.10	5.33 ± 0.10	1.33 ± 0.10	1.55 ± 0.05	330 ± 2.00	75.00 ± 1.00	13.00 ± 0.20
	(inch)	0.115 ± 0.004	0.210 ± 0.004	0.052 ± 0.004	0.061 ± 0.002	12.992 ± 0.079	2.953 ± 0.039	0.512 ± 0.008

SMAF	SYMBOL	E	F	P	P0	P1	T	W	W1
	(mm)	1.73 ± 0.10	5.50 ± 0.10	4.00 ± 0.10	4.00 ± 0.10	2.00 ± 0.10	0.20 ± 0.03	12.00 ± 0.30	14.70 + 2.00 - 1.00
	(inch)	0.068 ± 0.004	0.217 ± 0.004	0.157 ± 0.004	0.157 ± 0.004	0.079 ± 0.004	0.008 ± 0.001	0.472 ± 0.012	0.579 + 0.079 - 0.039

Company reserves the right to improve product design, functions and reliability without notice.

REV:A

## Marking Code

Part Number	Marking Code
SS34F-HF	SS34
SS36F-HF	SS36
SS310F-HF	SS310
SS315F-HF	SS315
SS320F-HF	SS320

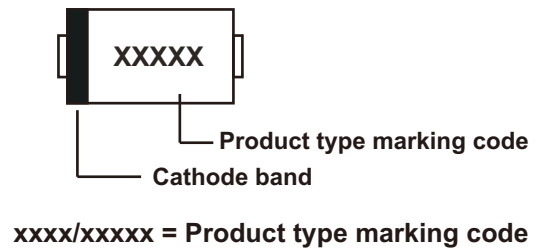

## Suggested PAD Layout

SIZE	SMAF	
	(mm)	(inch)
A	2.20	0.087
B	1.60	0.063
C	1.80	0.071
D	5.40	0.213

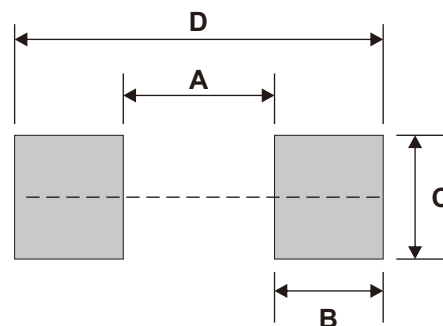

Note: 1. The pad layout is for reference purpose only.

## Standard Packaging

Case Type	REEL PACK	
	REEL ( pcs )	Reel Size (inch)
SMAF	10,000	13

# Mouser Electronics

Authorized Distributor

Click to View Pricing, Inventory, Delivery & Lifecycle Information:

[Comchip Technology:](#)

[SS320F-HF](#) [SS315F-HF](#) [SS34F-HF](#) [SS36F-HF](#) [SS310F-HF](#)